

USER MANUAL AND INSTALLATION GUIDE

DC INVERTER AIR TO WATER HEAT PUMP

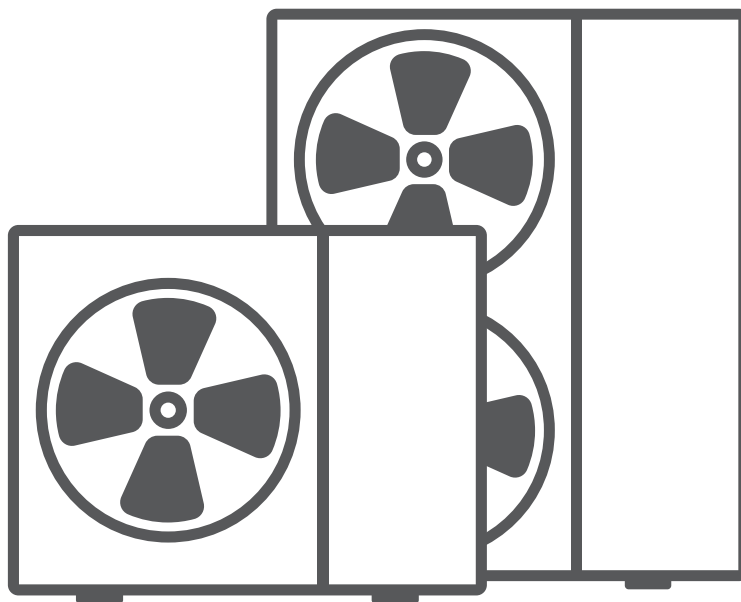

IMPORTANT NOTE:

Thank you very much for purchasing our product, Before using your unit, please read this manual carefully and keep it for future reference.

Contents

Part1. Before Use	01
1.1 Safety Precautions	01
1.2. Use.....	05
1.2.1 Main Interface.....	05
1.2.2 Definition of Buttons.....	05
1.2.3 Turn On/Off.....	06
1.2.4 Mode Switching	06
1.2.5 Temperature Setting	07
1.2.6 Timer Setting	08
1.2.7 User Setting.....	09
1.2.8 Current/Historical Alarm Query	20
Part2. Installation Instructions.....	21
2.1 Before Installation.....	21
2.2 Installation Site	21
2.3 Installation Precautions.....	22
2.4 Installation Requirements and Schematic Diagram	23
2.5 Water Pipe Part	29
2.6 Wiring Diagram	30
2.7 Power Line Diameter Selection	35
2.8 Pre-start Up	35
2.9 Connected to Controller	36
Part 3. WIFI Module Networking Manual	37
3.1 Installation of WIFI Module	37
3.2 Connection of WIFI Module.....	37
3.3 Device Homepage.....	39
3.4 Explanation	40
3.5 Detailed Information of the Units	42

Part 4. Maintenance and Repairing	43
Part 5. Error Input and Protection Alarm	44
5.1 Error Input and Protection Alarm	44
5.2 Other problem and repairing	46
Part 6. Warranty Card	47

Part1. Before Use

1.1 Safety Precautions

The precautions listed here are divided into the following types. They are quite important, so be sure to follow them carefully. Meanings of Warning, Caution and Prohibition symbols.

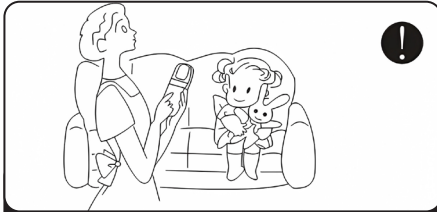

This appliance is not intended for use by persons, including children, with reduced physical, sensory or mental capabilities, or lack of experience and knowledge, unless they have been given supervision or instruction concerning use of the appliance by a person responsible for their safety. Children should be supervised to ensure that they do not play with the appliance.



Be sure to read this manual before use.

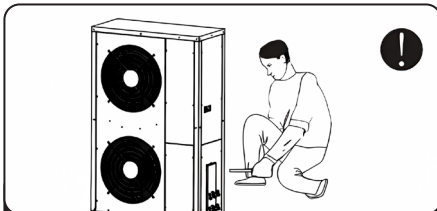

The installation, dismantlement and maintenance of the unit must be performed by qualified personnel. It is forbidden to do any changes to the structure of the unit. Otherwise injury of person or unit damage might happen.

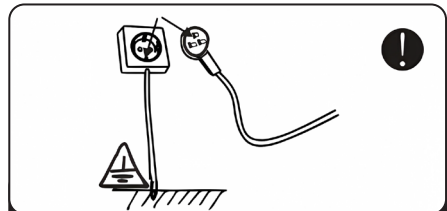

The power supply to the unit must be grounded.

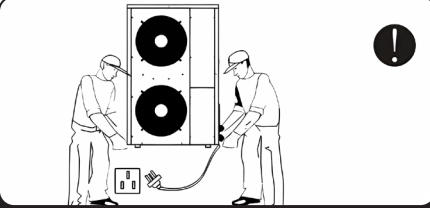

Make sure the power supply to the heat pump unit is off Before any operations are done on the unit. When the power cord gets looser or is damaged, always get a qualified person to fix it.



Keep the unit away from the combustible or corrosive environment.

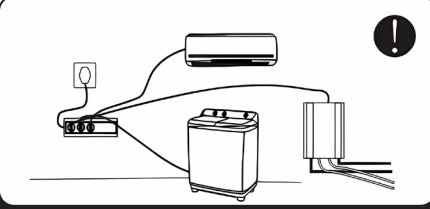

Use a dedicated socket for this unit, otherwise malfunction may occur.



Do not touch the air outlet grill when fan motor is running.

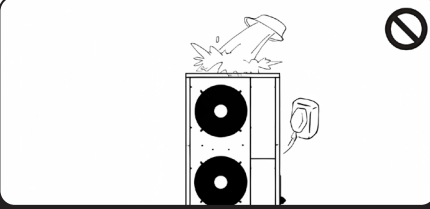

Water or any kind of liquid is strictly forbidden to be poured into the product, or may cause creepage or breakdown of the product.

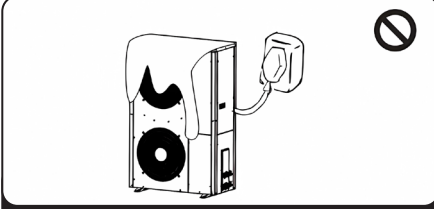

When running the unit, never cover clothes, plastic cloth or any other material that block ventilation on the product which will lead to low efficiency or even non-operation of this unit.

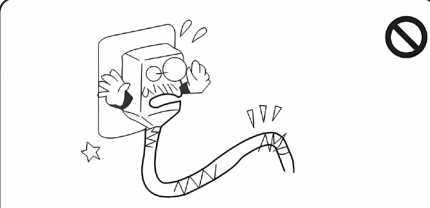

When the power cord gets loose or is damaged, always get a qualified person to fix it.

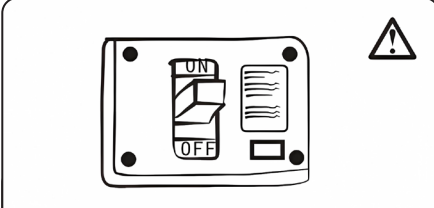

It is mandatory to use a suitable circuit breaker for the heat pump and make sure the power supply to the heater corresponds to the specifications. Otherwise the unit might be damaged.



Warning

- This appliance is not intended for use by persons, including children, with reduced physical, sensory or mental capabilities, or lack of experience and knowledge, unless they have been given supervision or instruction concerning use of the appliance by a person responsible for their safety. Children should be supervised to ensure that they do not play with the appliance.
- Be sure to read this manual before use.
- The installation, dismantlement and maintenance of the unit must be performed by qualified personnel. It is forbidden to do any changes to the structure of the unit. Otherwise injury of person or unit damage might happen.
- Make sure the power supply to the heat pump unit is off Before any operations are done on the unit. When the power cord gets looser or is damaged, always get a qualified person to fix it.
- Keep the unit away from the combustible or corrosive environment.
- Use a dedicated socket for this unit, otherwise malfunction may occur.



Caution

- Do not touch the air outlet grill when fan motor is running.
- Water or any kind of liquid is strictly forbidden to be poured into the product, or may cause creepage or breakdown of the product.
- When running the unit, never cover clothes, plastic cloth or any other material that block ventilation on the product which will lead to low efficiency or even non-operation of this unit.
- When the power cord gets loose or is damaged, always get a qualified person to fix it.



Prohibition

- It is mandatory to use a suitable circuit breaker for the heat pump and make sure the power supply to the heater corresponds to the specifications. Otherwise the unit might be damaged.

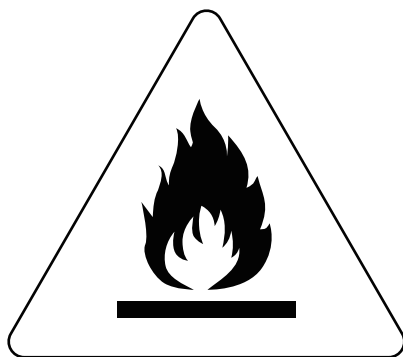

Caution: Risk of fire/
flammable materials

1.2. Use

1.2.1 Main Interface

Simple graph

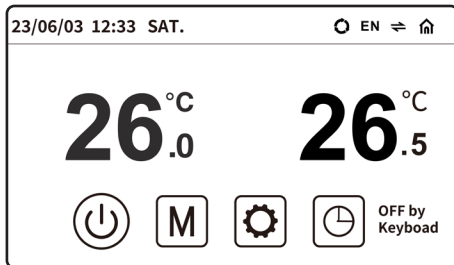

Dynamic graph

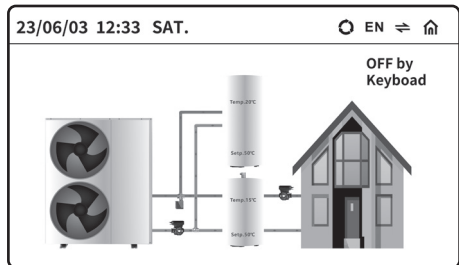

1.2.2 Definition of Buttons

icon	Meaning
	The current real-time cooling temperature display is in blue font; click to enter the user temperature setting.
	The current real-time heating temperature display is displayed in the orange font; click to enter the user temperature setting.
	The current real-time DHW temperature display is displayed in the red font; click to enter the user temperature setting.
	Cooling
	Heating
	Hot water
	On/off, red is on-state, and white is off-state.
	Switch dynamic/static interface.
	Alarm
	Timing, red means there is currently a timing, and white font means there is currently no timing.
	Mode setting key
SG++	Indicates entering the SG++ state
EN	Current language, click to select another language



1.2.3 Turn On/Off

In OFF state, the switch key color is white, Press  , it displays a selection box, select confirm to ON.

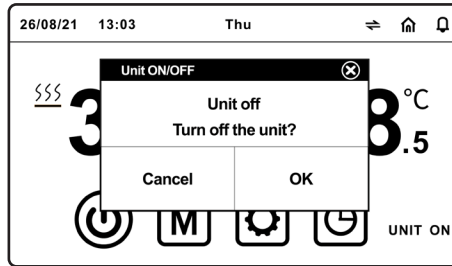
In ON state, the switch key color is red, press  , it displays a selection box, select confirm to OFF.



1.2.4 Mode Switching

Click  to set the unit mode. After selecting the required mode, click  to confirm, and click  to Cancel and exit the page.

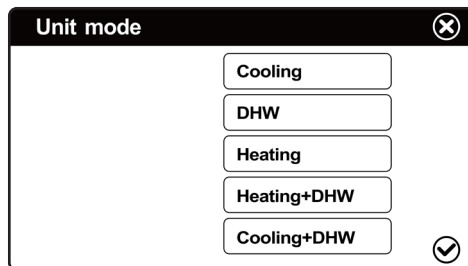

1.2.5 Temperature Setting

Click the ①② position of the real-time temperature to enter the temperature setting interface.

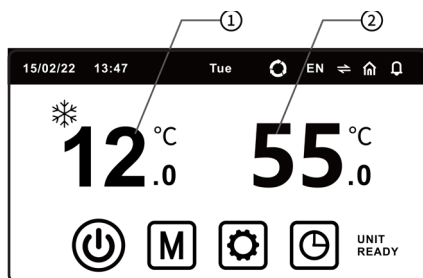

Set the temperature and hysteresis of each mode in the temperature setting interface.

Setpoint		✕
Heating setp.	45°C	
Cooling setp.	12°C	
Temp.diff.	5°C	
Hot water setp.	50°C	
Temp.diff.	5°C	✓

Cooling setp.: Cooling stop temperature setting

Heating setp. : Heating stop temperature setting

Temp. Diff. : when running heating/cooling mode,the difference between the unit's shutdown temperature and the set temperature after reaching the setting temperature.

Hot water setp. : Hot water tank temperature stop temperature setting

Temp. Diff. : when running hot water mode,the difference between the unit's shutdown temperature and the set temperature after reaching the setting temperature.

1.2.6 Timer Setting

Press the  button to pop up the timing control interface, and set the timing in the timing control interface.

Set timezone ON/OFF ✕

Timeband 1	ON	OFF			
<input type="checkbox"/> Weekday	08:00	08:00			
Timeband 2					
<input type="checkbox"/> Weekday	14:00	14:00			
Timeband 3					v
<input type="checkbox"/> Weekday	19:00	19:00			✓

Set timezone ON/OFF ✕

	Heating	Cooling	DHW	
Timeband 1	35°C	12°C	50°C	^
Timeband 1	35°C	12°C	50°C	
Timeband 1	35°C	12°C	50°C	✓

Timing period is not enabled/enabled: the switch is left when not enabled , and the switch is right when enabled

ON: Set for the timing power-on time.

OFF: Set for timing off time.

Timeband1/2/3, means that there are three timings that can be set, and each timing can set different hot water, heating and cooling temperatures.

Timed Water Return

The water return function can only be used when a integral hydronic tank is connected. Set G29 to YES in the engineering parameters to turn on the water return function. Water return is only performed within the following three time periods.

Set timezone ON/OFF ✕

	ON	OFF	
Timeband 1	08:00	08:00	^
Timeband 2	14:00	14:00	
Timeband 3	19:00	19:00	✓

1.2.7 User Setting

Press  to “Main Menu” as below :

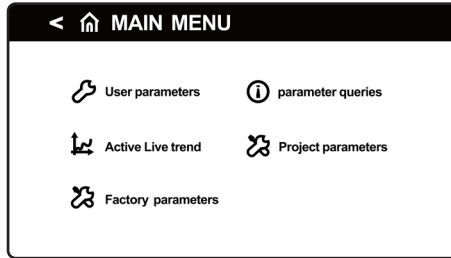

① **User Parameters** : Press  **User parameters** for user parameter setting

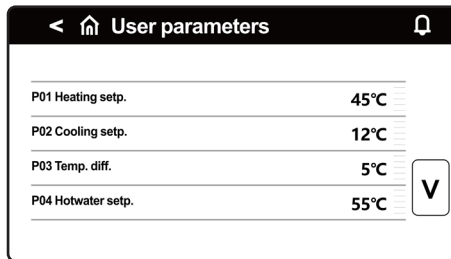

- P01 Heating setp. : Heating shutdown temperature
- P02 Cooling setp. : Cooling shutdown temperature
- P03 Temp. Diff. : The difference between the unit's shutdown temperature and the setting temperature after reaching the setting temperature.
- P04 Hot water setp. : Hot water shutdown temperature.
- P05 Temp. Diff. : When the machine is operating hot water mode, the difference between the unit's shutdown temperature and the set temperature after reaching the setting temperature.

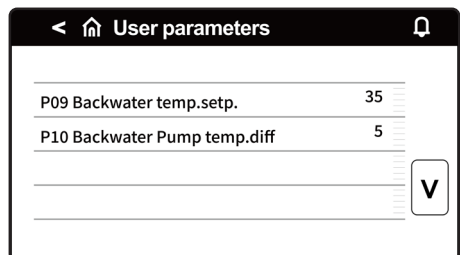
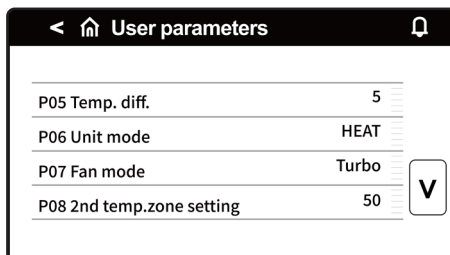

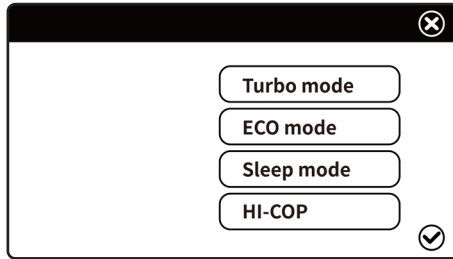

- P06 Unit mode: Modes choice of heat pumps.
- P07 Fan mode: Modes choice of fans. Turbo mode, ECO mode, Sleep mode and HI-COP mode are optional.
- P08 2nd temp.zone setting: Water outlet setting temperature in 2nd temp.zone
- P09 Backwater temp.setp.: Backwater setting temperature
- P10 Backwater pump temp.diff : Backwater pump differential temperature



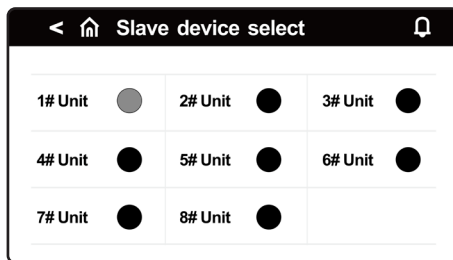

- Turbo mode, the compressor outputs according to the maximum capacity.
- ECO mode, the heat pump can automatically output capacity as required according to the ambient temperature.
- Sleep mode, the heat pump has low output capacity from 8 pm to 8 am, and high output at other times.
- HI-COP mode, the heat pump outputs according to the test capacity.

② Parameter query: Click  you can check the operating parameters.



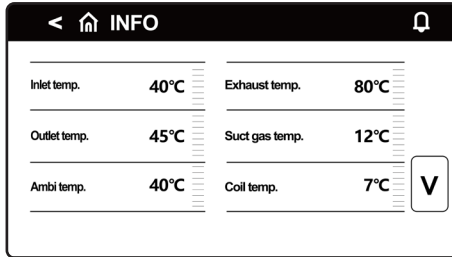

When a single unit is running, the 1# Unit icon is to the right  , click 1# unit to query the operating parameters of the 1# unit; if there is a linkage network, you can click 2#, 3#...8# to query the operating parameters of the corresponding unit, and the software version number. If the unit icon is displayed  , the unit is not connected.

press  or  Users can view more unit operating parameter just as temperature , Suct. press, Disch.press , etc.



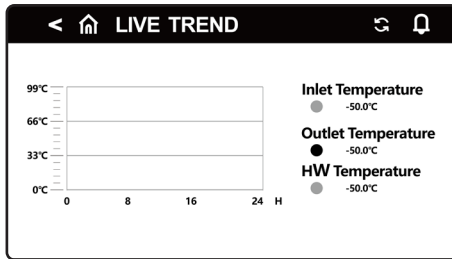

③ Press this  Active Live trend can check the curves of heating temperature, outlet water temperature, and hot water tank temperature changing with running time.



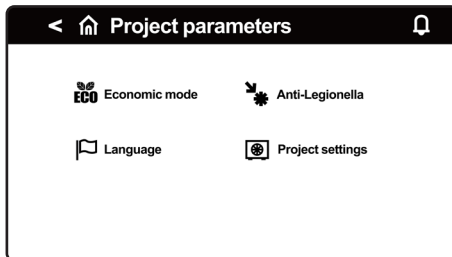

④ Engineering parameters: click here  Project parameters and enter the password to set the engineering parameter. This password is only provide for the construction contractor, if needed, please contact our engineers, it can be operated after receiving our authorization.

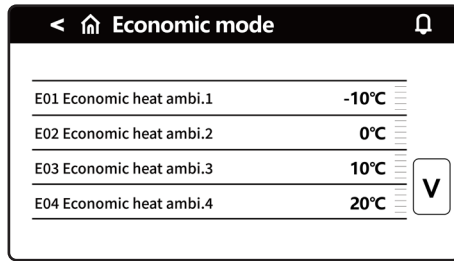

Click  Economic mode can enter the setting of relevant parameter on ECO mode as bellow.

press  or  Users can view more ECO mode about it.



Click  **Anti-Legionella** can enter relevant parameter settings for high temperature sterilization mode.

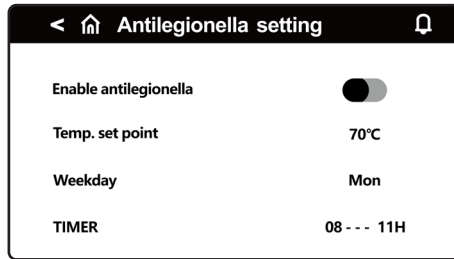

Enable antilegionella: Disable or enable sterilization function, right is enable ;

Temp. Set point: Sterilization temperature setting;

Weekday: Sterilization work days, once a week;

TIMER: Sterilization time point, once a week;

Press  **Language** to enter the language selection interface;

Press  **Project settings** to access the relevant settings of project parameters;

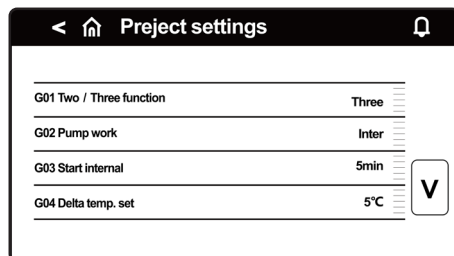

Two/Three function :Click "two" and "three" to select whether the current unit is double supply or triple supply;

DC Pump work: The working mode of the inverter water pump can be selected as demand, always on, intermittently on;

Start internal: The interval time for the start of the inverter water pump in intermittent mode;

Delta temp. set: The inverter water pump controls the current temperature difference between the incoming and outgoing water;

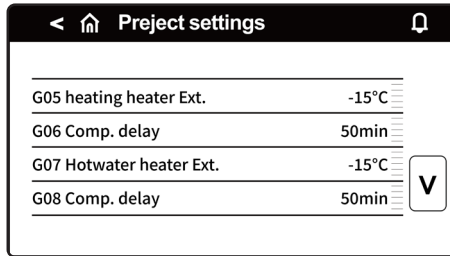

Setting	Value
G05 heating heater Ext.	-15°C
G06 Comp. delay	50min
G07 Hotwater heater Ext.	-15°C
G08 Comp. delay	50min

Heating heater Ext.: Start-up ambient temperature of heating electric heater;

Comp. Delay: heating electric heater start delay;

Hot water heater Ext.: Start-up ambient temperature of hot water electric heater;

Comp. Delay: Hot water electric heater start delay;

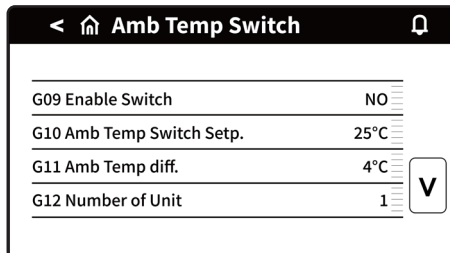

Setting	Value
G09 Enable Switch	NO
G10 Amb Temp Switch Setp.	25°C
G11 Amb Temp diff.	4°C
G12 Number of Unit	1

● Enable Switch:

(With this function , the heat pump can do heating /cooling automatically based on the ambient temperature setting)

- Enable Switch -No : turn off the automatic cooling/heating mode which is based on the ambient temperature; Original setting is Disable before delivery .
- Enable Switch -Yes : turn on the automatic cooling/heating mode which is based on the ambient temperature.
- AmbTemp Switch Setp.: Switch the ambient temperature setting point of the cooling/heating mode;
- when the ambient temperature is lower than the set point-hysteresis, the unit will automatically switch to heating or hot water + heating;
- when the ambient temperature is higher than the set point +In case of hysteresis, the unit will automatically switch to cooling or hot water+refrigeration;
- when the ambient temperature is higher than the set point-hysteresis and lower than the set point + hysteresis maintains the current mode
- AmbTemp.diff: The difference between the ambient temperature switching mode and the set temperature.

Number of Unit:

- When the units are networked and the operating parameters of multiple units need to be queried, select the corresponding number of units

Fault reset:Reset current fault

⑤ SG Ready Operating Instructio

● SG Operational Status Table:

Signal status		Screen Display	Operation Mode	Status Description
SG	EVU			
OFF	ON	SG-	Mode 1	Insufficient energy, the heat pump is forced to shut down, and the antifreeze can operate normally.
OFF	OFF	NULL	Mode 2	The heat pump is running normally.
ON	OFF	SG+	Mode 3	Automatically set the hot water to the highest temperature, the electric heating is turned off by default (can be set), store as much energy as possible, and switch to heating or cooling after meeting the requirements.
ON	ON	SG++	Mode 4	The energy is cheap, the heat pump adjusts the hot water temperature setting value to the highest temperature of the system operation, the electric heating is turned on, and the heating/cooling is turned after the temperature is met.

● The main screen is in the top bar and shows the current mode of operation of the unit:

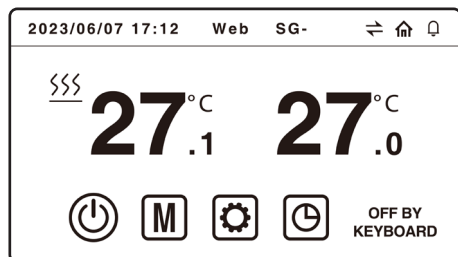

Mode1 (SG-)

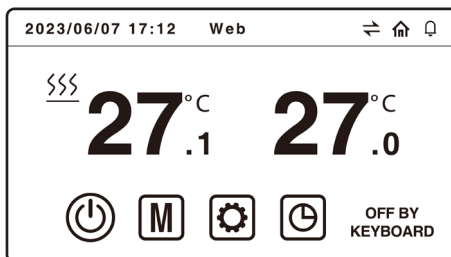

Mode2 (None)

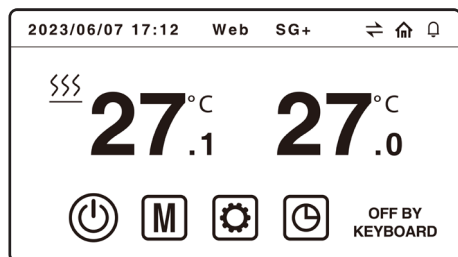

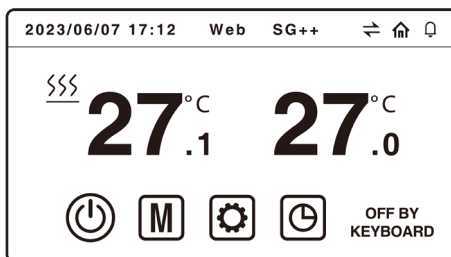

Mode3 (SG+)



Mode4 (SG++)

- **SG Setting Method:**

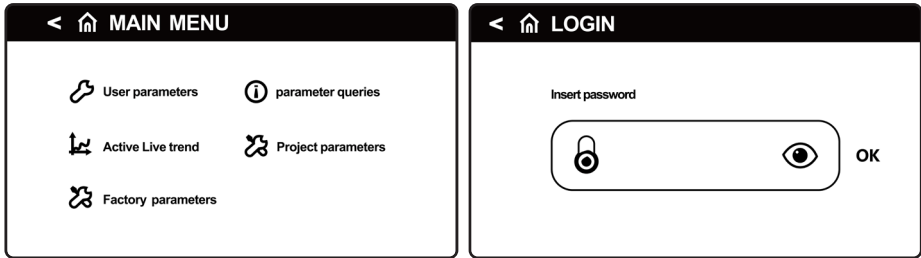

Turn On/Off SG Function

Press the  button in the main screen and then press the  **Project parameters** button to enter the project parameter password entry page as shown below:

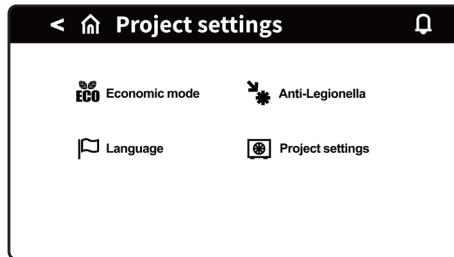

- On the above page, enter the password (0816) and click "OK" to enter the "Project parameters" page shown below.



- After entering the project parameters page, click the  button to enter the "Project settings" page, and use the  button to page to the G13 parameters on the "Project settings" page, as shown below:

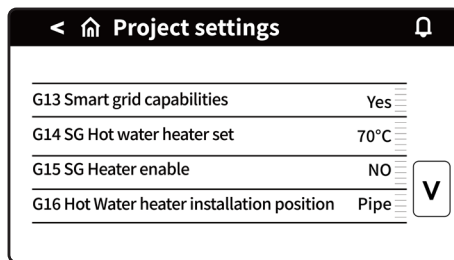

- G13 Smart grid capabilities:

When set to "YES", the SG function operates, when set to "No", the SG function does not operate.

- Description of other parameters:

G14 SG Hot water heater set: when entering mode 4, sets the stopping temperature after the hot water heater has been forced on.

G15 SG Heater enable: when entering mode 4, does the hot water heater turn on. When set to "YES", the hot water heater is forced on and works together with the heat pump, when set to "NO", the hot water heater is not forced on.

SG++ Hotwater temp.setting: when entering mode 4, the stopping temperature after forced opening of the hot water heater.

G16 Hot water heater installation position: The position of the hot water heater should be selected according to the actual installation.

Tips:

When the G13 Smart grid capabilities is set to "YES", it is recommended to install the hot water heater in the tank and to set this option to "TANK" so that the system will switch to heating or cooling mode when the hot water mode reaches the set temperature, and the hot water heater will be continued to turn on until the hot water temperature is higher than "G14 SG Hot water heater set", the hot water heater stops. If the hot water heater is installed in the pipe and "Pipe" is selected, the system will switch to heating or cooling mode when the hot water mode reaches the set temperature, but the hot water temperature can not heat up to "G14 SG Hot water heater set" because the hot water heater is installed in the pipe.

G17 SG/EVU signal check time: SG/EVU signal detection time, once every 60S.

G18 SG Hot water set diff 1: when entering mode 3, hot water set a temperature correction value, set to 2 as an example, the final hot water set temperature = original set temperature + 2 when actually running.

G19 SG Heat set set diff 1: when entering mode 3, heating set a temperature correction value, set to 2 as an example, the final heating set temperature = original set temperature + 2 when actually running.

G20 SG Cool set diff 1: when entering mode 3, cooling set a temperature correction value, set to 2 as an example, the final cooling set temperature = original set temperature - 2 when actually running.

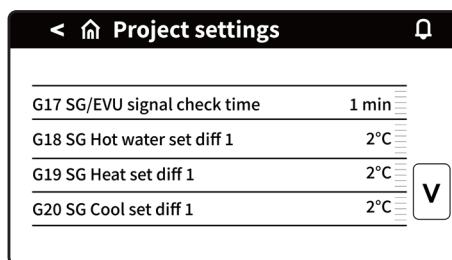

The screenshot shows a mobile application interface for 'Project settings'. At the top, there is a navigation bar with a back arrow, a home icon, the text 'Project settings', and a notification bell icon. Below the navigation bar is a list of settings. Each setting is displayed on a line with a horizontal separator below it. The settings are: G17 SG/EVU signal check time (1 min), G18 SG Hot water set diff 1 (2°C), G19 SG Heat set diff 1 (2°C), and G20 SG Cool set diff 1 (2°C). To the right of the G19 and G20 settings is a vertical slider control with a 'V' icon.

Setting	Value
G17 SG/EVU signal check time	1 min
G18 SG Hot water set diff 1	2°C
G19 SG Heat set diff 1	2°C
G20 SG Cool set diff 1	2°C

G21 SG Hot water set diff 2: when entering mode 4, hot water set a temperature correction value, set to 5 as an example, the final hot water set temperature = original set temperature + 5 when actually running.

G22 SG Heat set set diff 2: when entering mode 4, heating set a temperature correction value, set to 5 as an example, the final heating set temperature = original set temperature + 5 when actually running.

G23 SG Cool set diff 2: when entering mode 4, cooling set a temperature correction value, set to 5 as an example, the final cooling set temperature = original set temperature - 5 when actually running.

G24 No.of slaves operating hot water mode.

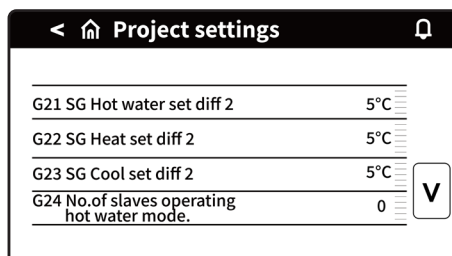

The screenshot shows a mobile application interface for 'Project settings'. At the top, there is a navigation bar with a back arrow, a home icon, the text 'Project settings', and a notification bell icon. Below the navigation bar is a list of settings. Each setting is displayed on a line with a horizontal separator below it. The settings are: G21 SG Hot water set diff 2 (5°C), G22 SG Heat set diff 2 (5°C), G23 SG Cool set diff 2 (5°C), and G24 No.of slaves operating hot water mode. (0). To the right of the G23 and G24 settings is a vertical slider control with a 'V' icon.

Setting	Value
G21 SG Hot water set diff 2	5°C
G22 SG Heat set diff 2	5°C
G23 SG Cool set diff 2	5°C
G24 No.of slaves operating hot water mode.	0

G25 Auxiliar controller function : Auxiliary controller function enabled. Please set to enable when connecting the integral hydronic tank.

G26 Solar auxiliary heating function :Solar auxiliary heating function enabled.

G27 Solar pump starting hysteresis: The return difference temperature of the solar pump. The solar temperature - the water tank temperature > this value, the solar pump is started.

G28 Solar pump max tank temp. : The highest temperature of the water tank during solar heating. The water tank temperature > this value, the solar pump stops running.

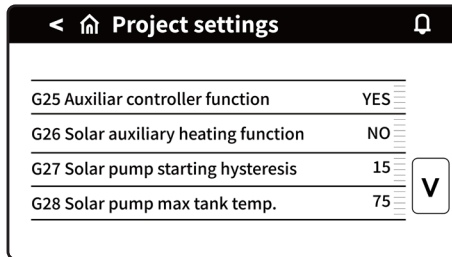

G29 Backwater function: Backwater Function Enabled.

G30 2nd temp.zone function: 2nd temp.zone function Enabled.

G31 Temp.diff(H/C): Heating/cooling mode differential temperature

G32 Temp.diff(DHW): DHW mode differential temperature

G33 Backwater pump temp diff: Backwater pump differential temperature

G34: The main screen displays the inlet temperature or outlet temperature

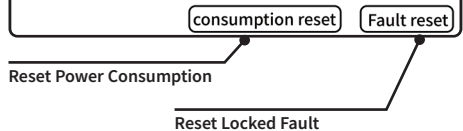
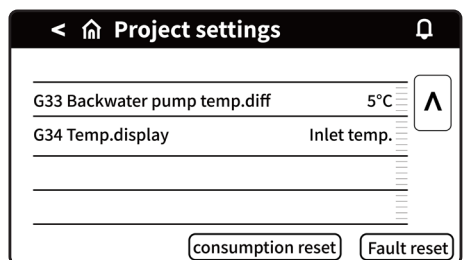
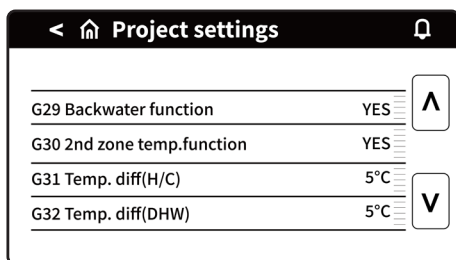

⑥ Factory parameters: Press here  Project parameters and enter the password to query and set the factory parameters, this password needs to contact the technical engineer, and the operation can only be done after authorization.

1.2.8 Current/Historical Alarm Query

 The flashing icon in the upper right corner indicates that there is an alarm. Press this icon to pop up the current alarm interface.

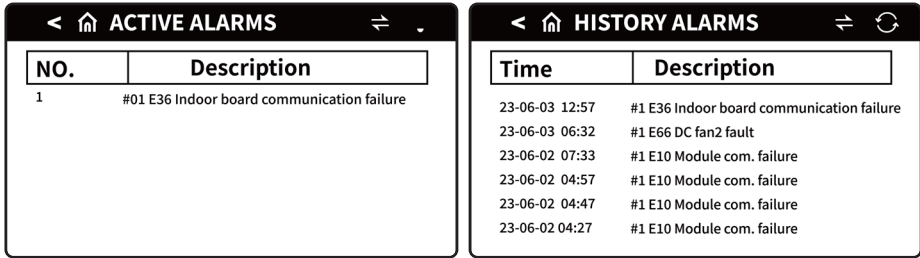

ACTIVE ALARMS	
NO.	Description
1	#01 E36 Indoor board communication failure

HISTORY ALARMS	
Time	Description
23-06-03 12:57	#1 E36 Indoor board communication failure
23-06-03 06:32	#1 E66 DC fan2 fault
23-06-02 07:33	#1 E10 Module com. failure
23-06-02 04:57	#1 E10 Module com. failure
23-06-02 04:47	#1 E10 Module com. failure
23-06-02 04:27	#1 E10 Module com. failure

Press  to show a dialog box for whether to delete historical alarms, press "YES" to delete historical alarms, and press "NO" to cancel the operation.

Press  to switch between current alarm and historical alarm.

Press  to return to main menu.

Part2. Installation Instructions

2.1 Before Installation

- **Before Installation**

Be sure to confirm the model name and the serial number of the unit.

- **Handling**

Due to relatively large dimensions and heavy weight, the unit should only be handled using lifting tools with slings. The slings can be fitted into foreseen sleeves at the base frame that are made specifically for this purpose.



Caution

- There is flammable refrigerant in the unit and it should be installed in a well-ventilated site. If the unit is installed inside, an additional refrigerant detection device and ventilation equipment must be added in accordance with the standard EN378. Be sure to adopt adequate measures to prevent the unit from being used as a shelter by small animals.
- Small animals making contact with electrical parts can cause malfunction, smoke or fire. Please instruct the customer to keep the area around the unit clean.

2.2 Installation Site



Warning

- To avoid injury, do not touch the air inlet or aluminum fins of the unit.
Do not use the grips in the fan grills to avoid damage.
- The unit is top heavy! Prevent the unit from falling due to improper inclination during handling.

2.3 Installation Precautions

- Select an installation site where the following conditions are satisfied and one that meets with your customer's approval.
 - Places that are well-ventilated.
 - Places where the unit does not disturb neighbors.
 - Safe places which can bear the unit's weight and vibration and where the unit can be installed at an even level.
 - Places where there is no possibility of flammable gas or product leak.
 - The equipment is not intended for use in a potentially explosive atmosphere.
 - Places where servicing space can be well ensured.
 - Places where the units' piping and wiring lengths come within the allowable ranges.
 - Places where water leaking from the unit cannot cause damage to the location (e.g. in case of a blocked drain pipe).
 - Places where rain can be avoided as much as possible.



Prohibition

Do not install the unit in places often used as a work space. In case of construction work (e.g. grinding etc.) where a lot of dust is created, the unit must be covered.

- Do not place any object or equipment on top of the unit (top plate).
- Do not climb, sit or stand on top of the unit.
- Be sure that sufficient precautions are taken in case of refrigerant leakage according to relevant local laws and regulations.
- Don't install the unit near the sea or where there is corrosion gas.

- When installing the unit in a place exposed to strong wind, pay special attention to the following. Strong winds of 5 m/sec or more blowing against the unit's air outlet causes a short circuit (suction of discharge air), and this may have the following consequences:
 - Deterioration of the operational capacity.
 - Frequent frost acceleration in heating operation.
 - Disruption of operation due to rise of high pressure.
 - When a strong wind blows continuously on the front of the unit, the fan can start rotating very fast until it breaks.

2.4 Installation Requirements and Schematic Diagram

- Heat pump each side to wall or barrel should be keep certain distance, air outlet to barrel distance should $\geq 2\text{m}$, air inlet distance to wall or barrel $\geq 0.5\text{m}$, bottom distance to ground $\geq 0.2\text{m}$, other side distance should be enough for installation or repairing.
- Heat pump should be installed on concrete basic or steel bracket, and anti-shock pad should be put between heat pump and basic or bracket. Then use expansion bolt to fix heat pump on bracket.
- Water drainage pipe and ditch should be set around heat pump and water pipes and water tank. When testing or repairing, maybe need drain plenty of water, and when heat pump is working, there are some condensed water flow down.
- **The following requirements must be met.**
 - Only use shielded wires for Ethernet and RS485 communication networks, and install them in UV resistant PVC pipes;
 - If voltage outside of calibration is used, it may seriously damage the system;
 - Use cable heads suitable for the corresponding terminals. Loosen each screw and insert the cable head, then tighten the screws.
 - After completing the work, gently pull the cable to check if it is fixed properly;
- **Do not open this terminal when powered on.**
 - Low temperature operation may cause a significant decrease in display screen reaction speed. This phenomenon is considered normal and not will be identified as a fault.
- **Avoid touching any live parts on the terminal.**
 - Ensure accurate cable fixation and avoid contact with live parts to prevent accidental disconnection of the terminal.

Overall Dimensions:

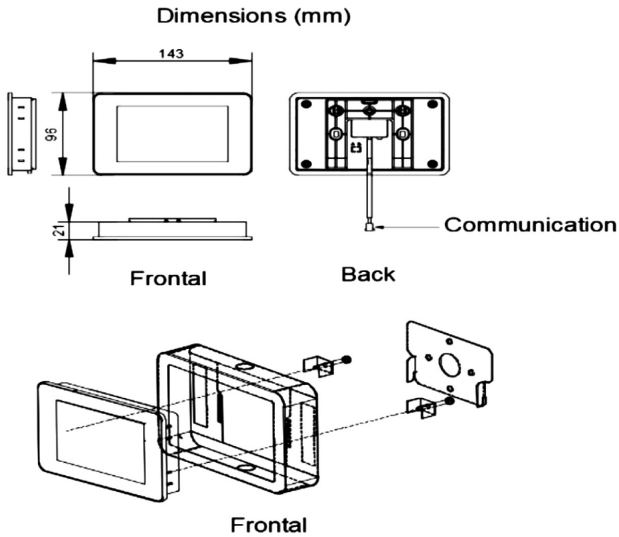

Common to all models:

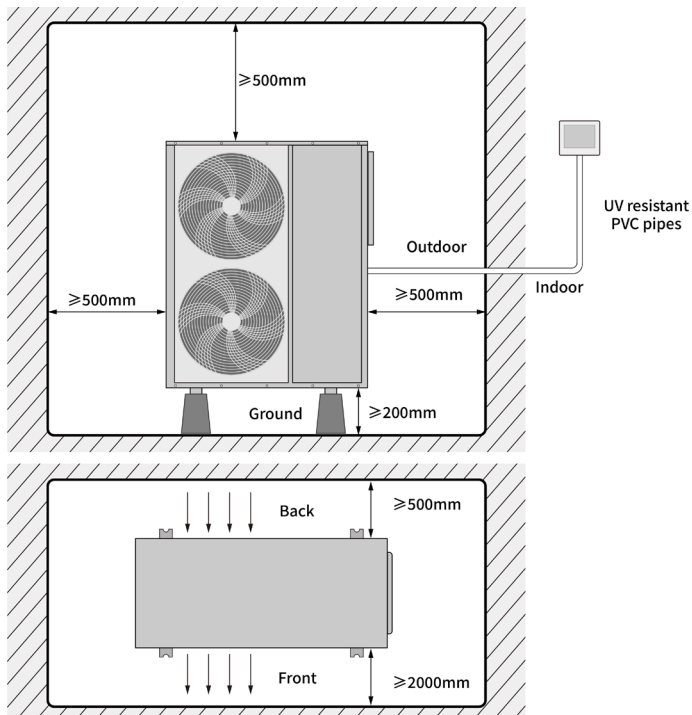

Cascade Installation Requirements

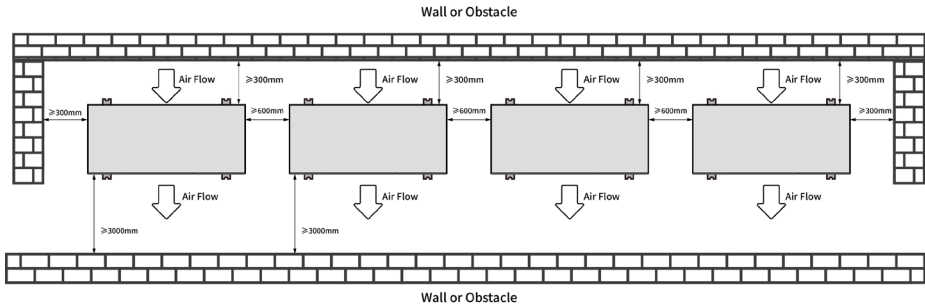

Secondary Circulation System

Symbol	Name
	3-way valve
	2-way valve
	Ball valve
	Non-return valve
	Filter
	Water pump
	Temp sensor
	Release valve
	Expansion tank

Notice:

1. Pls select the right modes according to your demand then install it according to the installation diagram. If only hot water function required, pls select heating+hot water mode and then put the hot water sensor into the hot water tank.
2. Two-way valve and BV valve are optional for installation. Only If you need to control the temperature by different zone, then pls install both.
3. Fan coil can be controlled by linkage with the secondary circulation pump . Meanwhile, a passive linkage thermostat shall be installed.
4. If the heat pump unit has a built-in pump, P2 in the schematic diagram does not need to be installed.

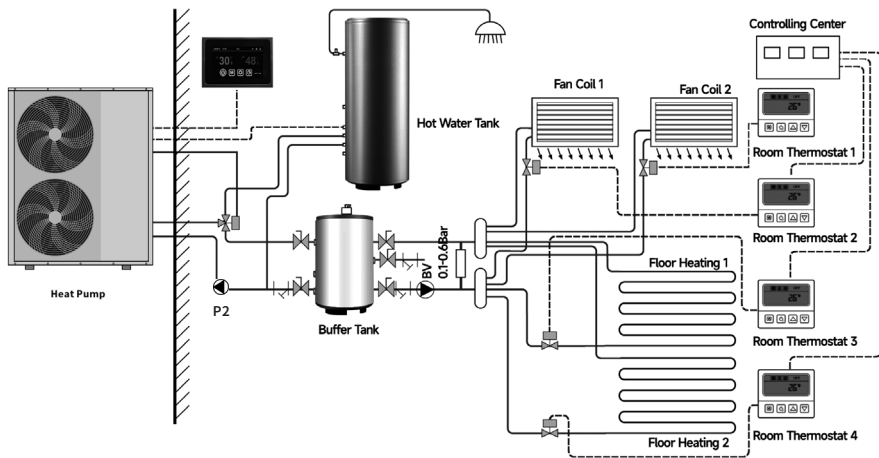

DC inverter air source heat pump

Unit Overall Dimension

Model	Overall Dimensions (L × D × H)
CGK015V3L-B	990*375*655
CGK025V3L-B/CGK-025V3L-B CGK020V4P-B	1110*475*810 1053*475*755
CGK030V3L-B/CGK-030V3L-B CGK030V4P-B/CGK-030V4P-B	1110*475*810
CGK040V3L-B/CGK-040V3L-B CGK040V4P-B/CGK-040V4P-B	1110*475*960
CGK050V3L-B/CGK-050V3L-B CGK050V4P-B/CGK-050V4P-B	1110*475*1355
CGK060V3L-B/CGK-060V3L-B CGK060V4P-B/CGK-060V4P-B	1110*475*1355
CGK-080V3L-B	1110*475*1455
CGK-100V3L-B	950*1950*900



Caution

- Ground the unit.
- Grounding resistance should be according to local laws and regulations.
- Do not connect the ground wire to gas or water pipes, lightning conductors or telephone ground wires.
- Incomplete grounding may cause electric shocks.
 - Gas pipes: Fire or an explosion might occur if the gas leaks.
 - Water pipes: Hard vinyl tubes are not effective grounds.
 - Lightning conductors or telephone ground wires: Electrical threshold may rise abnormally if struck by a lightning bolt.
- Install the power wire at least 3 feet (1 meter) away from televisions or radios to prevent interference or noise. (Depending on the radio waves, a distance of 3 feet (1 meter) may not be sufficient to eliminate the noise.)
- Do not wash the unit. This may cause electric shocks or fire. The appliance must be installed in accordance with national wiring regulations. If the supply cord is damaged, it must be replaced by the manufacturer, its service agent or similarly qualified persons in order to avoid a hazard.
- If the supply cord is damaged, it must be replaced by the manufacturer or its service agent or a similarly qualified person.
- The appliance shall be installed in accordance with national wiring regulations.
- When installing multiple air conditioners in a centralized manner, please confirm the load balance of the three-phase power supply, and multiple units are prevented from being assembled into the same phase of the three-phase power supply.
- Do not install the unit in the following places:
 - Where there is mist of mineral oil, oil spray or vapors. Plastic parts may deteriorate, and cause them to come loose or water to leak.
 - Where corrosive gases (such as sulfurous acid gas) are produced. Where corrosion of copper pipes or soldered parts may cause refrigerant to leak.
 - Where there is machinery which emits electromagnetic waves. Electromagnetic waves can disturb the control system and cause equipment malfunction.

- Where flammable gases may leak, where carbon fiber or ignitable dust is suspended in the air or where volatile flammables such as paint thinner or gasoline are handled. These types of gases might cause a fire.

- Where the air contains high levels of salt such as near the ocean.

- Where voltage fluctuates a lot, such as in factories.

- In vehicles or vessels.

- Where acidic or alkaline vapors are present.

- **DISPOSAL:** Do not dispose this product as unsorted municipal waste. Collection of such waste separately for special treatment is necessary. Do not dispose of electrical appliances as municipal waste, use separate collection facilities. Contact your local government for information regarding the collection systems available. If electrical appliances are disposed of in landfills or dumps, hazardous substance can leak into the ground water and get into the food chain, damaging your health and well-being.
- An all-pole disconnection device which has at least 3mm clearances in all poles , and have a leakage current that may exceed 10mA, the residual current device (RCD) having a rated residual operating current not exceeding 30mA, and disconnection must be incorporated in the fixed wiring in access.
- Before installation, check whether the user's power supply meets the electrical installation requirements of unit (including reliable grounding, leakage, and wire diameter electrical load, etc.). If the electrical installation requirements of the product are not met, the installation of the product is prohibited until the product is rectified.
- This appliance can be used by children 8 years old and above and persons with reduced physical, sensory or mental capabilities or lack of experience and knowledge if they are supervised or given instruction on using the unit in a safe manner and understand the hazards involved. Children should not play with the unit. Cleaning and user maintenance should not be done by children without supervision.
- Children should be supervised to ensure that they do not play with the appliance.
- Confirm the safety of the installation area (walls, floors, etc.) without hidden dangers such as water, electricity, and gas, before wiring/pipes.
- Product installation should be fixed firmly. Take reinforcement measures, when necessary.

2.5 Water Pipe Part

- Install a valve at the highest point of each water circulations for releasing air from water system.
- A Y-shape filter is very important in front of circulating water pump of heat pump.
- If more pieces' heat pump installed in one water pipe system, the connection of these heat pumps can't be in series, only can be in parallel or independent.
- A hot water tank with heat exchanger coils is required in the installation drawing, and The coils are sized to match the following manufacturer's calibrated sizes; if not, please get in touch with a technical engineer.



schematic diagram of threaded heat exchange coils

Model	Recommended specification and length of heat exchange coil for hot water tank
CGK015V3L-B	304 Stainless steel bellows, DN32*6000mm;
CGK025V3L-B/CGK-025V3L-B CGK020V4P-B	304 Stainless steel bellows, DN32*10000mm;
CGK030V3L-B/CGK-030V3L-B CGK030V4P-B/CGK-030V4P-B	304 Stainless steel bellows, DN32*10000mm;
CGK040V3L-B/CGK-040V3L-B CGK040V4P-B/CGK-040V4P-B	304 Stainless steel bellows, DN32*10000mm;
CGK050V3L-B/CGK-050V3L-B CGK050V4P-B/CGK-050V4P-B	304 Stainless steel bellows, DN32*15000mm;
CGK060V3L-B/CGK-060V3L-B CGK060V4P-B/CGK-060V4P-B	304 Stainless steel bellows, DN32*15000mm;
CGK-080V3L-B/CGK-100V3L-B	304 Stainless steel bellows, 2*DN32*10000mm; 2*DN32*15000mm;

2.6 Wiring Diagram

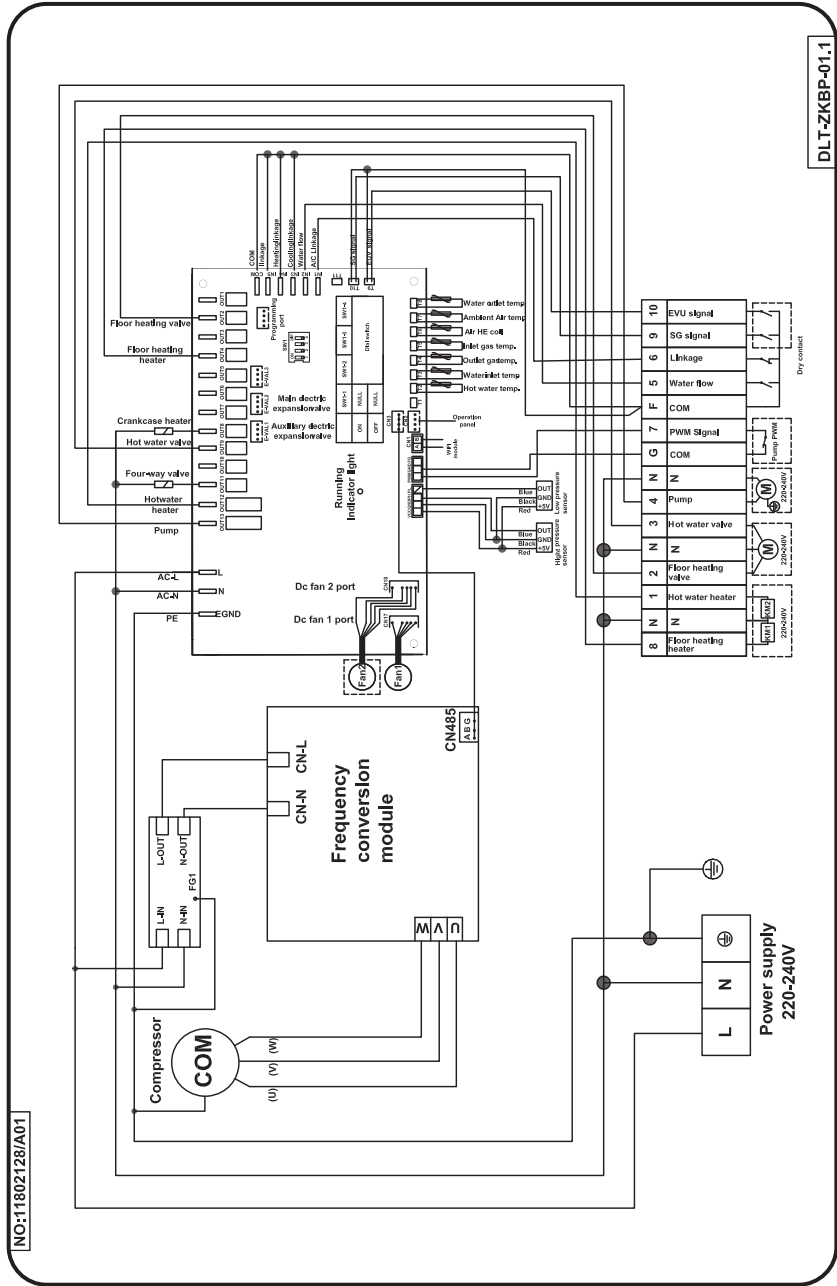

The wiring diagram is based on the actual wiring.

R32 Voltage: 220V-240V/50Hz

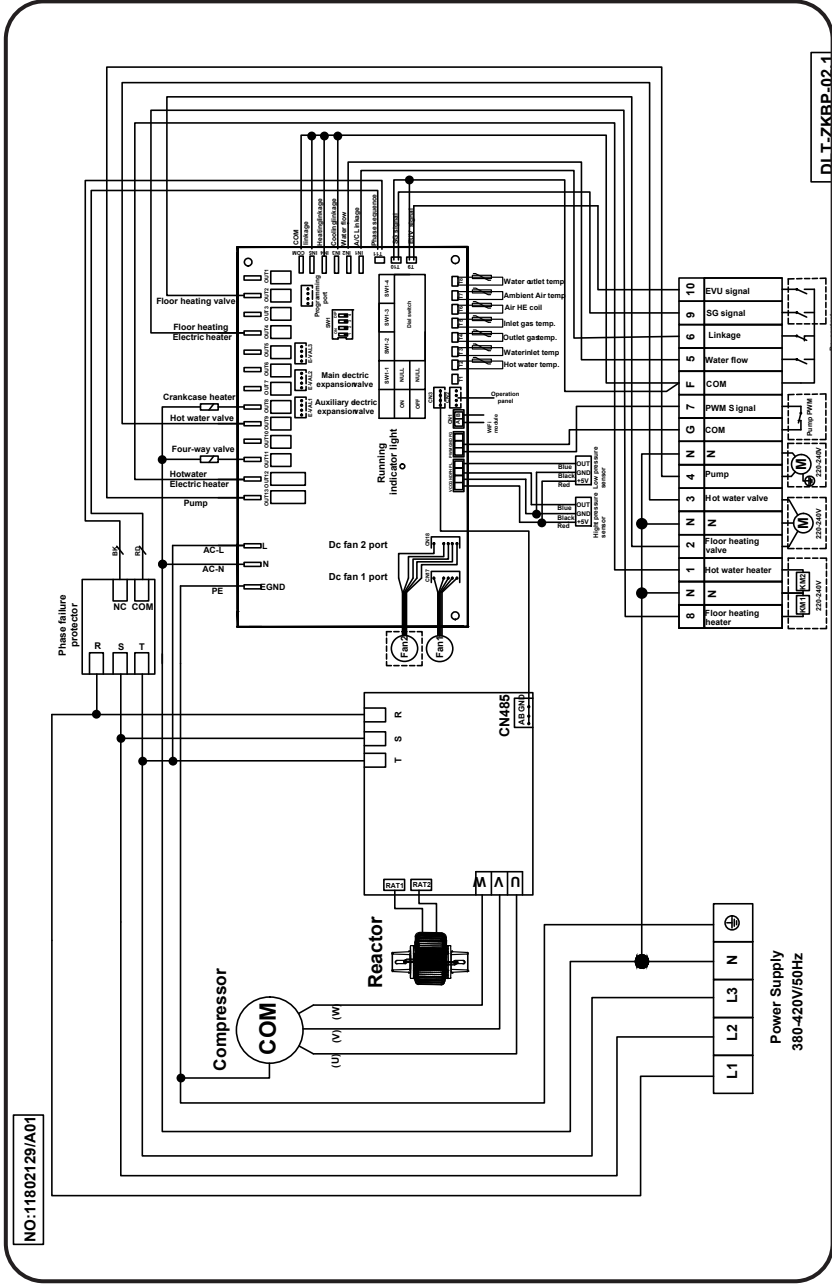

R32 Voltage:380V-420V/3N~/50Hz

The wiring diagram is based on the actual wiring.

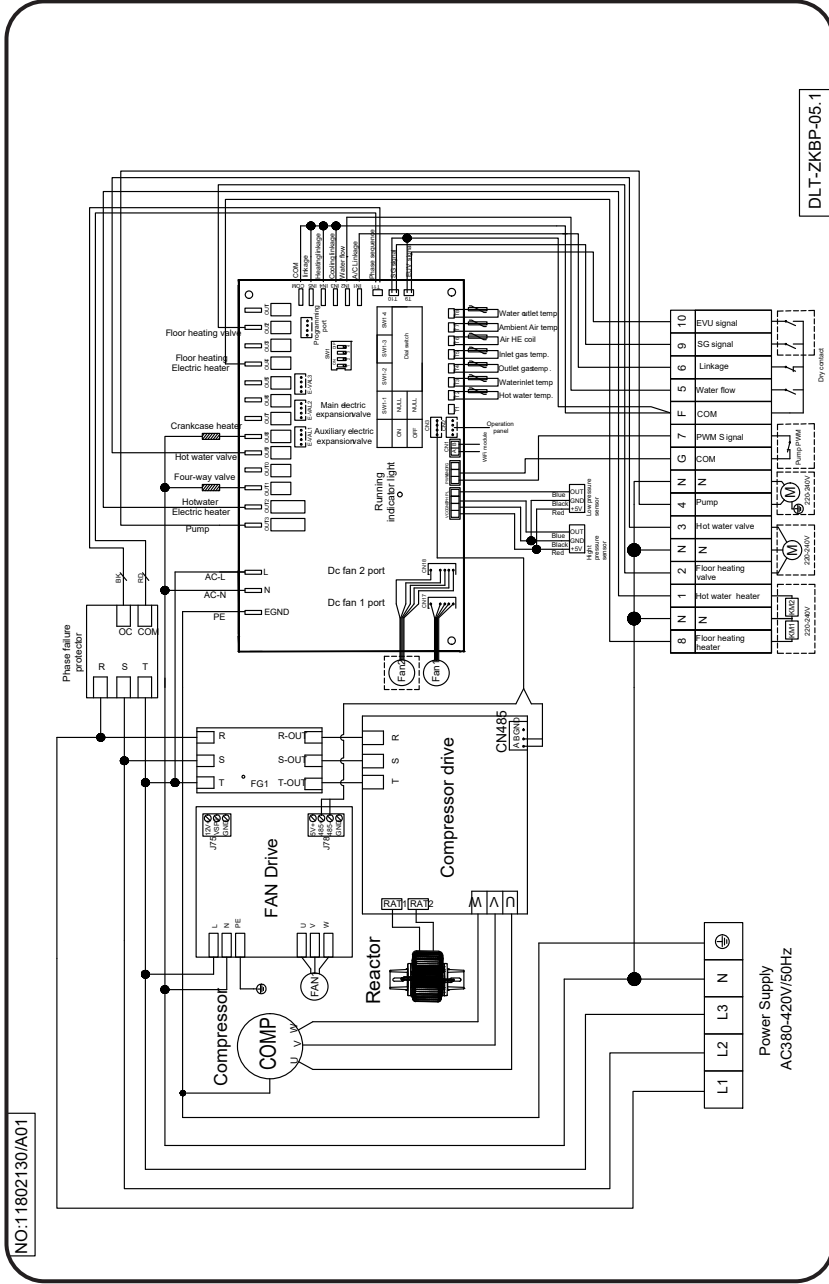

R32 Voltage: CGK-100V3L-B CGK-101V3L-B 380V-420V/3N~/50Hz

The wiring diagram is based on the actual wiring.

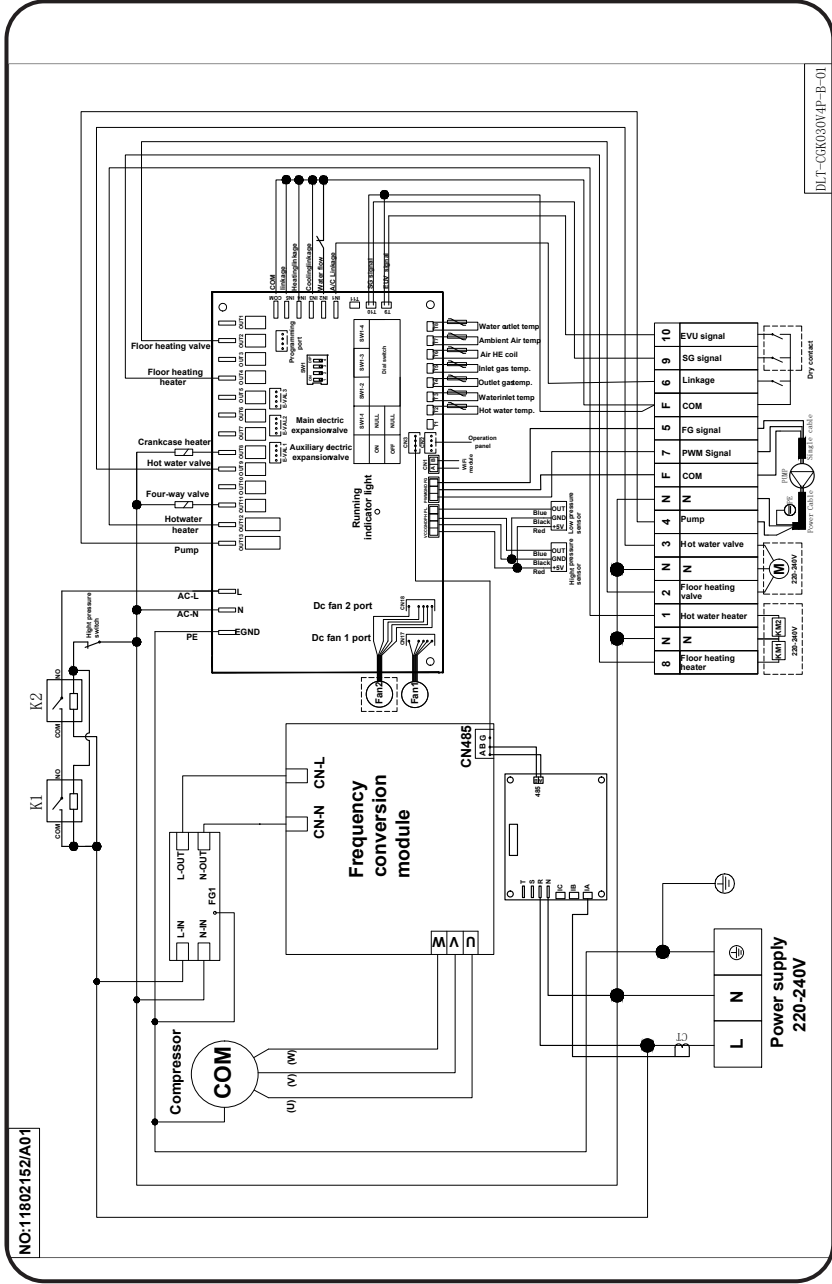

R290 Voltage: 220V-240V/50Hz

The wiring diagram is based on the actual wiring.

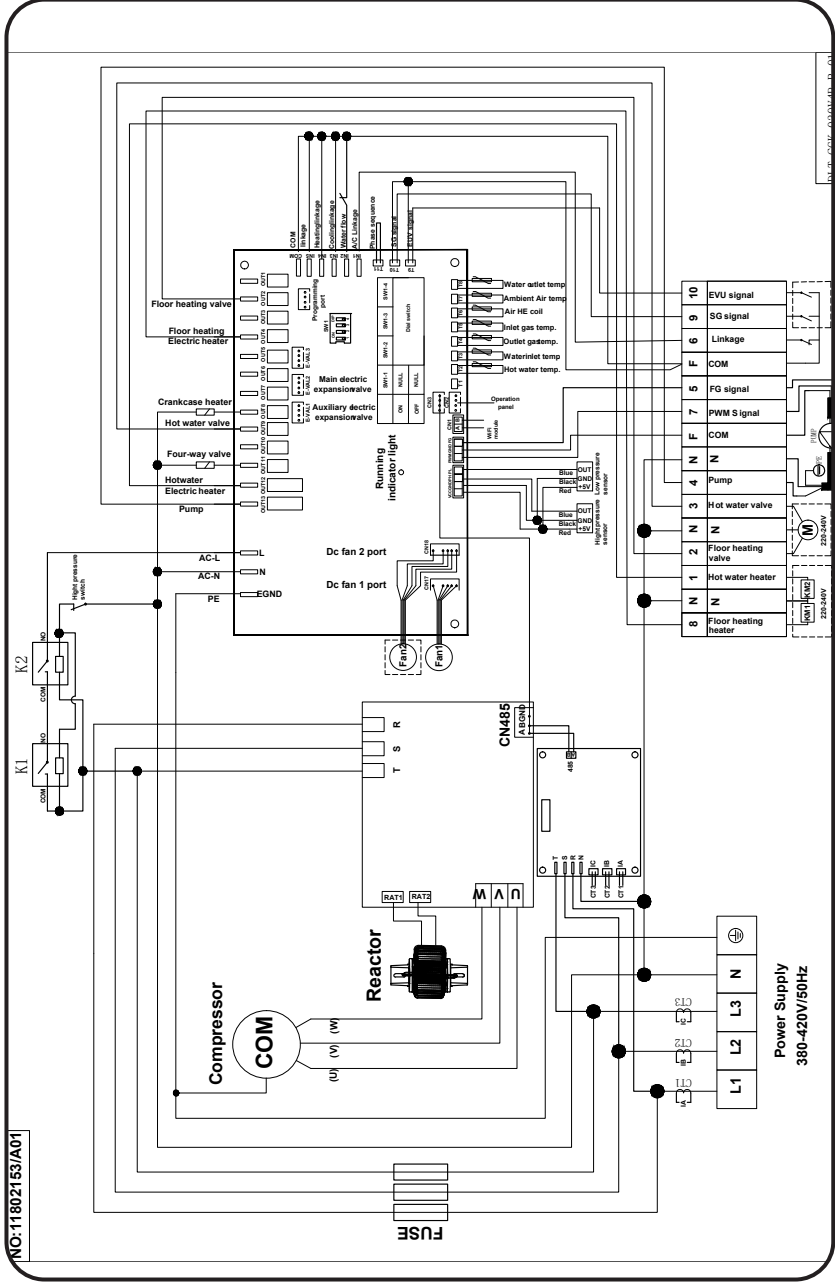

R290 Voltage:380V-420V/3N~/50Hz

The wiring diagram is based on the actual wiring.

2.7 Power Line Diameter Selection

Model	Line (mm ²)	Max. Current(A)	Model	Line (mm ²)	Max. Current(A)
CGK015V3L-B	2.5	9.68	CGK025V3L-B CGK-025V3L-B	1.5	6.53
CGK025V3L-B CGK020V4P-B	4	14.79	CGK-030V3L-B CGK-030V4P-B	2.5	8.31
CGK030V3L-B CGK030V4P-B	4	18.88	CGK-040V3L-B CGK-040V4P-B	2.5	10.83
CGK040V3L-B CGK040V4P-B	6	24.6	CGK-050V3L-B CGK-050V4P-B	4	13.28
CGK050V3L-B CGK050V4P-B	6	30.17	CGK-060V3L-B CGK-060V4P-B	4	14.94
CGK060V3L-B CGK060V4P-B	6	33.94	CGK-080V3L-B	4	21.35
			CGK-100V3L-B	6	23.74

The specific selection depends on the current corresponding to the actual model.

2.8 Pre-start Up

① Checking Before Pre-start Up

- Check if the water pipe is connected well and if there is any leakage. The water supply valve is open.
- Make sure the water flow is enough and meet the demand of the heat pump selected and water flow smoothly without air. In cold area, pls make sure that the water flow is without freezing.
- Check if the power cable is connected well and properly grounded.
- Check if fan blade is blocked by the fixing plate of fan blade and fan blade protecting grill.
- Check if the tank has been filled with water or enough water volume that can meet the demand of heat pump running.
- The water outlet of the heat pump needs to install an automatic air exhaust valve so that the water system can be discharged to the outside when there is gas.



If everything above is OK, the unit can start up. If any of them fails, please improve it.

② Pre-start Up

- After check completely and confirm no problem for installation, the unit can be power to start up.
- After connect power supply, heat pump delay 3mins to start. Check carefully is there is some abnormal noise or vibration or if the working current is normal or if water temp increasing is normal.
- After the unit is working properly for 10 minutes without any problem, then the pre-start up is usefully completed. If not, pls refer to Service and Maintenance Chapter to solve the problem.

2.9 Connected to Controller

When the control terminals of "Linkage" and "COM" in the heat pump are disconnected, the cooling or heating operation will stop immediately. When they are connected and the unit meets the startup conditions, the machine will start. Therefore, by connecting the dry contact signal of the thermostat's start/stop to the "Linkage" and "COM" of the heat pump, it can achieve linked start/stop with the heat pump.

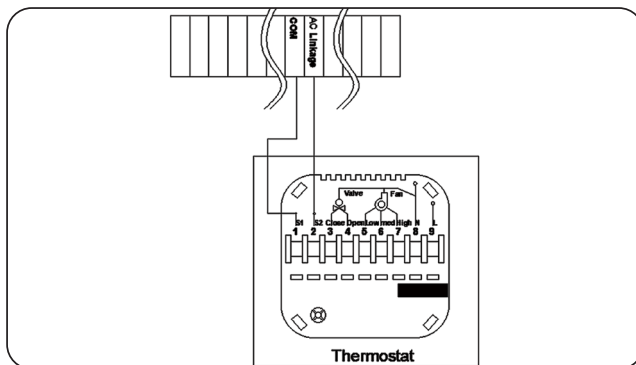

Part 3. WIFI Module Networking Manual

(For Models with WiFi)

3.1 Installation of WIFI Module

Open the plastic handle on the back of the unit to find the communication line of the WIFI module. Open the rear lower maintenance panel to find the accessory bag of the WIFI module, and then connect it according to ①②③ as shown below.

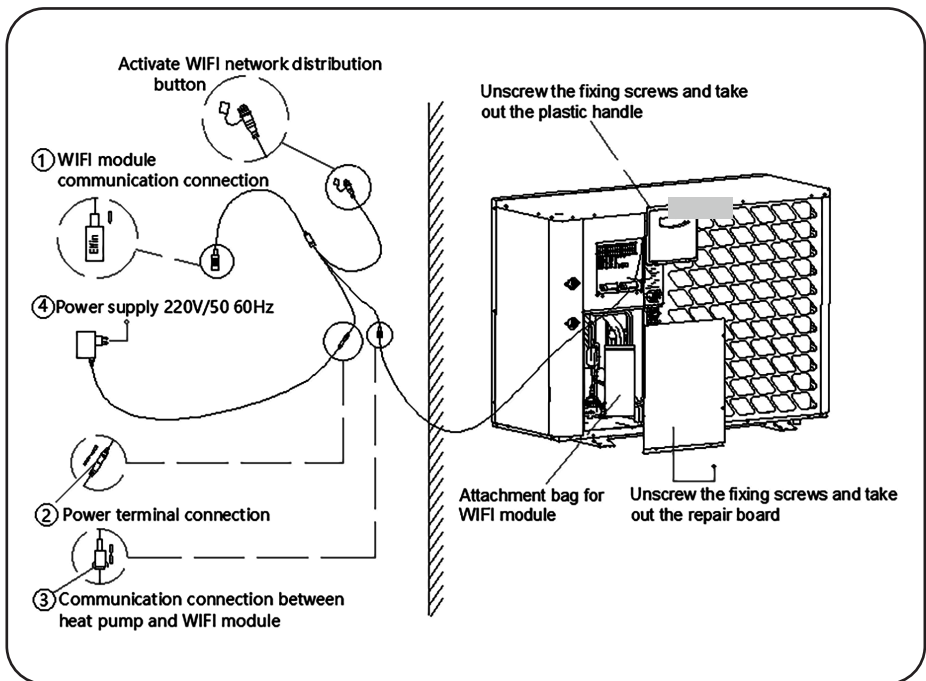

3.2 Connection of WIFI Module

When used for the first time, the WIFI module needs to be equipped with a network. The steps to configure the network are as follows:

Step 1: Register

Download the APP and enter the login page. Click New User Registration to register with your phone number or email. After successful registration, enter your username and password to log in. (To download the APP, you need to scan the QR code below and then choose to open it in the browser to download)

iOS App: Search for "Heat Pump Pro" in the Apple Store to download.
Android App: Search for "Heat Pump" in the Google Play Store or scan the QR code below to download.

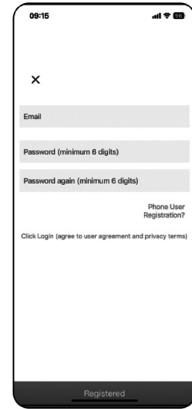

Step 2:

Add Device to LAN

For modules that have not been connected to the network, you need to add equipment to the LAN. Connect the power supply ④ of the heat pump and WIFI module to the indoor 220V power plug. The green light of the module will flash slowly.

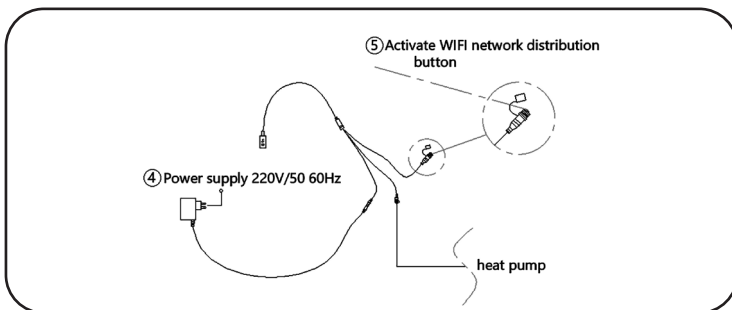

After entering My Device, click "⊕" in the upper left corner to enter the Add device page. The name of the WIFI currently connected to your phone will be displayed in the box above. Enter the WIFI password and gently press the raised button on the connection cable ⑤ (picture above). Note that pressing the button takes less than 2 seconds, wait for about 2~3

seconds, the green light of the WiFi module starts to flash quickly, and the WiFi adapter enters pairing mode;

Click “Add device” until the connection is successful. Then click the arrow to see the currently connected APP displayed in the list.

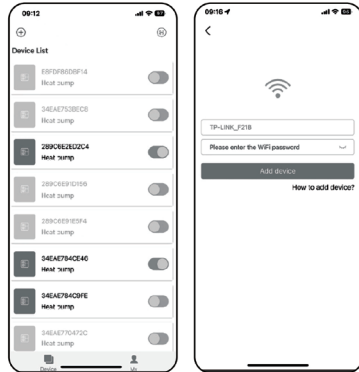

● Scan the QR Code to Add a Device:

For modules that have been bound to the APP, you can scan the QR code to add a device. If the module is connected to the network, the module will automatically connect to the Internet after powering on. For modules that have been bound to the APP, click the icon on the far left of the APP device list to display the binding QR code of this module. If others want to bind the module, they can click "📄" directly and scan the QR code to bind the module.

3.3 Device Homepage

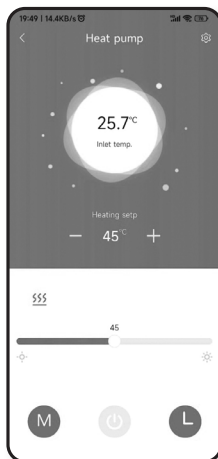

3.4 Explanation

1. Click a device in the device list to enter this page.
2. The background color of the bubble indicates the current operating state of the device:
 - Gray indicates that the device is in the shutdown state, at this time, you can change the working mode, set the mode temperature, set the timing, or you can press the key to switch on and off.
 - Multi-color indicates that the device is turned on, each working mode corresponds to a different color, orange indicates heating mode, red indicates hot water mode, and blue indicates cooling mode.
 - When the device is in the power-on state, you can set the mode temperature, set the timer, press the key to switch on and off, but you cannot set the working mode (that is, the working mode can only be set when the device is off)
3. The bubble shows the current temperature of the device.
4. Below the bubble is the set temperature of the device in the current operating mode.
5. Set the temperature is about 45°C , Press button, each click adds or subtracts the current setting value to the device.
6. Below the setting temperature is the Fault and Alert. When the device starts to alarm, the specific Alert reason will be displayed next to the yellow warning icon. In case of device Fault and Alert, the Fault and Alert content will be displayed on the right side of this area. Click this area to jump to the detailed Error Information.

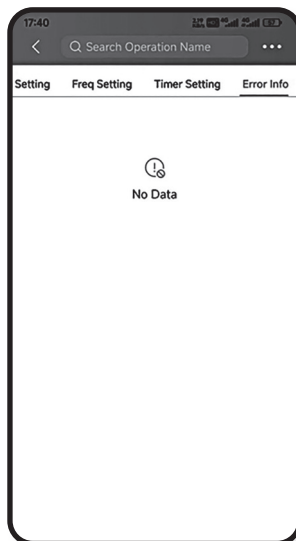

7. Immediately below the fault alarm area, display the current working mode, heat pump, fan and compressor in sequence (corresponding blue icon when it is on, but not displayed when it is off).
8. The slide bar below is used to set the temperature in the current mode. Slide the slider left and right to set the allowable temperature in the current working mode.
9. The bottom three buttons are in order from left to right: working mode, device switching machine and device timing. When the current background is color, the working mode button cannot be clicked.
10. Click Work Mode to see the mode selection menu, and you can set the working mode of the device (black is the current setting mode of the device).

The diagram as beloww

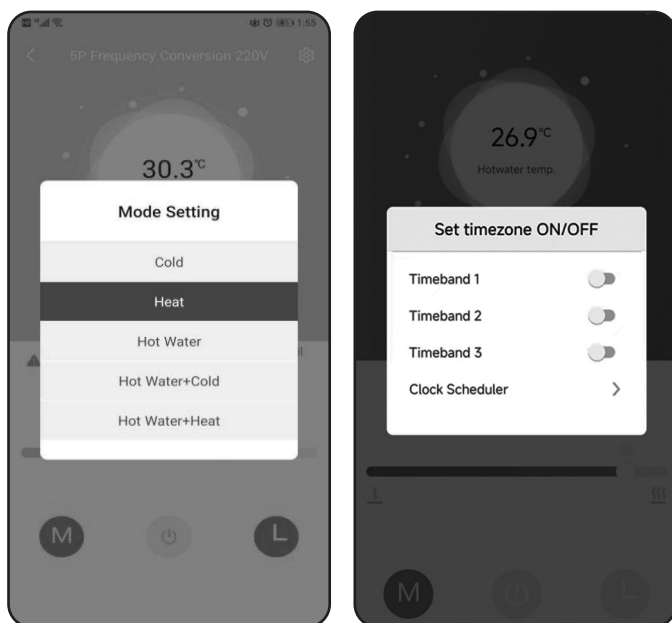

- Click "on/off" and set "on/off" command to the device.
- Click the device Timer to see the Timer Settings menu. Click the Clock Schedule to set the device Timer function.

3.5 Detailed Information of the Units

Note:

Click this Main Interface menu on the upper right corner to enter this setting page.

Users with manufacturer rights can check all the functions, including: User mask, defrost, other parameters, factory settings, manual control, query parameters, time edit, error info.

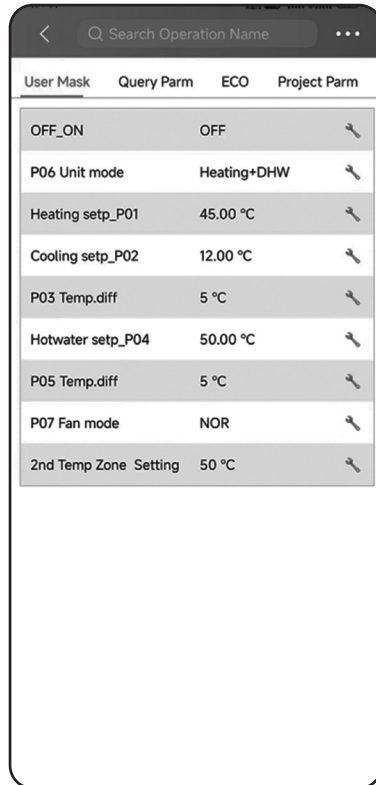

The screenshot shows a mobile application interface for unit settings. At the top, there is a search bar labeled "Search Operation Name" and a menu icon. Below the search bar, there are four tabs: "User Mask", "Query Parm", "ECO", and "Project Parm". The "Query Parm" tab is selected. The main content area displays a list of parameters with their current values and a lock icon to the right of each row. The parameters and their values are:

Parameter	Value	Lock Icon
OFF_ON	OFF	🔒
P06 Unit mode	Heating+DHW	🔒
Heating setp_P01	45.00 °C	🔒
Cooling setp_P02	12.00 °C	🔒
P03 Temp.diff	5 °C	🔒
Hotwater setp_P04	50.00 °C	🔒
P05 Temp.diff	5 °C	🔒
P07 Fan mode	NOR	🔒
2nd Temp Zone Setting	50 °C	🔒

User with user rights, only can check part of the functions: User mask, query parameters, Time Edit, alarms.

Part 4. Maintenance and Repairing

Maintenance Tips

- The heat pump unit is a highly automated equipment. The unit status check is carried out regularly during use. If the unit can be maintained and maintained for a long time and effectively, the unit's operational reliability and service life will be unexpectedly improved.
- Users should pay attention to the use and maintenance of this unit: all safety protection devices in the unit are set before leaving the factory, do not adjust by yourself.
- Always check whether the power supply and electrical system wiring of the unit is firm, whether the electrical components are malfunctioning, and if necessary, repair and replace them in time.
- Always check the water system's hydration, the water tank safety valve, the liquid level controller and the exhaust device to work properly, so as to avoid the air circulation into the system and reduce the water circulation, thus affecting the unit's heating capacity and unit operation reliability.
- The unit should be kept clean and dry and well ventilated. Regularly clean (1-2 months) air-side heat exchangers to maintain good heat transfer.
- Always check the operation of each component of the unit, check the oil pipe at the pipe joint and the gas valve, and ensure that the refrigerant of the unit is not leaking.
- Do not stack any debris around the unit to avoid blocking the air inlet and outlet. The unit should be clean and dry and well ventilated.
- If the downtime is long, the water in the unit piping should be drained, and the power supply should be cut off and the protective cover should be placed. When running again, check the system thoroughly before starting up.
- If the unit fails and the user cannot solve the problem, please inform the company's special maintenance department in order to send someone to repair it in time.
- The main unit condenser cleaning, the company recommends using a 50 ° C concentration of 15% hot oxalic acid to clean the condenser, start the host with a circulating water pump for 20 minutes, and finally rinse with tap water 3 times. (It is recommended to reserve a three-way interface when installing the pipe and seal one interface with a wire plug) in case of cleaning. Do not wash the condenser with a corrosive cleaning solution. The water tank needs to be removed after a period of use (usually two months, depending on local water quality).

Part 5. Error Input and Protection Alarm

5.1 Error Input and Protection Alarm

Fault codes	notes
Er 01	Phase sequence fault
Er 03	Water flow failure
Er 04	Antifreeze in winter
Er 05	High pressure fault
Er 06	Low pressure fault
Er 07	Solar sensor temp. failure
Er 08	Phase voltage too low
Er 09	Communication failure
Er 10	Communication failure of frequency conversion module (alarm when communication between outer board and drive board is disconnected)
Er 12	Exhaust temp too high protection
Er 14	Water tank temperature sensor fault
Er 15	Water inlet temperature sensor fault
Er 16	Evaporator coil temperature sensor fault
Er 17	Electric meter communication failure
Er 18	Exhaust temperature fault
Er 19	Phase voltage imbalance
Er 20	Abnormal protection of frequency conversion module
Er 21	Ambient temperature sensor fault
Er 23	Cooling outlet water temperature supercooling protection
Er 26	Cooling evaporator temp. too low
Er 27	Outlet water temperature sensor fault
Er 28	Backwater TP failure
Er 29	Return gas temperature sensor fault
Er 30	Indoor outlet temp. 2 failure
Er 32	Heating too high outlet water temperature protection
Er 33	Coil temperature too high
Er 34	WT elec. Heater protection
Er 35	Indoor outlet temp. 1 failure
Er 36	Indoor board communication failure
Er 42	Cooling coil temperature sensor failure
Er 43	AC elec. Heater protection
Er 44	Air temp too low
Er 45	Air Temp. too high

Er 64	DC fan 1 fault
Er 65	Bus current failure
Er 66	DC fan 2 fault
Er 67	Low pressure switch failure
Er 68	High pressure switch failure
Er 69	Too low pressure protection
Er 70	Too high pressure protection
Er 98	Expansion board communication failure
Er 99	All communication failure
E20_1	IPM over current
E20_2	Comp. lost synchronism
E20_4	Reserve
E20_8	Comp. lost phase
E20_16	DC voltage low
E20_32	DC voltage high
E20_64	Heatsink temp high
E20_128	Heatsink TP failure
E20_257	Module com. failure
E20_258	AC lost phase
E20_260	AC over current
E20_264	AC input voltage low
E20_272	High pressure fault
E20_288	IPM temp too high
E20_320	Comp peak current high
E20_384	PFC temp high

5.2 Other problem and repairing

No.	Error	Possible reason	Method
1	Heat pump doesn't run	<ol style="list-style-type: none"> 1. Power supply cable is loose 2. The fuse of power supply is fused. 	<ol style="list-style-type: none"> 1. Cut off the power supply to check and repair. 2. Change the fuse.
2	Heating capacity is too small	<ol style="list-style-type: none"> 1. Refrigerant is not enough 2. Water system insulating is not good 3. Air heat exchanger is dirty 4. Water heat exchanger scaled 	<ol style="list-style-type: none"> 1. Check leakage and repair and refill gas 2. Improve the insulation 3. Clean air heat exchanger 4. Clean water heat exchanger
3	Compressor doesn't run	<ol style="list-style-type: none"> 1. Power supply has error 2. Cable connecting is loose 3. Compressor is overheat 	<ol style="list-style-type: none"> 1. Check reason and solve 2. Check loose and repair 3. Check reason and repair
4	Compressor noise is loud	<ol style="list-style-type: none"> 1. Expansion valve damaged lead to liquid entering compressor 2. The internal parts of compressor damaged 3. Compressor lack of oil 	<ol style="list-style-type: none"> 1. Change expansion valve 2. Change compressor 3. Compensate oil for compressor
6	Fan motor doesn't run	<ol style="list-style-type: none"> 1. Fan blade fixing screw is loose 2. Fan motor damaged 3. Fan motor capacitance damaged 	<ol style="list-style-type: none"> 1. Tight the screw 2. Change fan motor 3. Change the capacitance
6	Compressor run, but not heat	<ol style="list-style-type: none"> 1. There is not refrigerant at all 2. Compressor damaged 	<ol style="list-style-type: none"> 1. Check leakage and repair 2. Change compressor

Part 6. Warranty Card

Warranty card

Product model:

Bar code:

Buyer			Address
Invoice No.			Date
Repair date	Repair record		Repairer

Items of warranty:

1. Warranty terms: _____ ; Within warranty, any problem because of quality, please contact us for support.
2. When repair needed, please show the warranty card and invoice of order or other proof.
3. We don't afford the problem that is caused by re-fitment or adding other function by user.
4. Warranty card and invoice or other purchasing proof will be invalid if alerted.
5. Please keep the warranty card and invoice or other purchasing proofs well, we will need these for service purpose.
6. We will not provide free warranty for below conditions:
 - (1) without proof;
 - (2) errors caused by re-fitment or not correct operating;
 - (3) damage caused by not professional people operating;
 - (4) faulty by moving or falling;
 - (5) faulty caused by natural disaster;
 - (6) After the power failure, the water in the pipeline of the unit was not discharged, which caused the unit to freeze.

CERTIFICATE

Product Model: _____

Bar code: _____



Scan to download the APP